

Features

Regulated Converters

- 4:1 Wide input voltage range
- 1.6kVDC Isolation
- UL, IEC/EN60950 and EN50155 certified
- Efficiency up to 88%
- OVP, OCP & OTP
- +105°C max. case temperature



RPA20-AW

20 Watt

1"x1"

Single & Dual Output

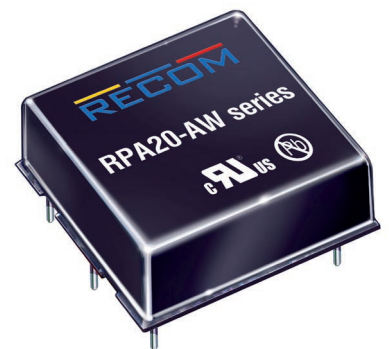

UL60950-1 certified
IEC/EN60950 certified
EN50155 certified

Description

The RPA20-AW series are high power density, wide input voltage range 20W DC/DC converters in an industry standard 1"x1" case size. Despite their small size, the RPA20-AW converters are fully specified devices with output currents up to 6Amps, up to 88% efficiency, no minimum load, 1600VDC isolation, tight regulation and low ripple/noise figures. The outputs are also fully protected against over-temperature, short circuits, overcurrent and overvoltage and the single output version offers a ±10% trim range. A heatsink option is available to extend the operating temperature range. The converters are UL and EN50155 certified and will find many uses in railway and industrial applications where board space is at a premium.

Selection Guide

Part Number	Input Voltage Range [VDC]	Output Voltage [VDC]	Output Current [mA]	Input ⁽¹⁾ Current [mA]	Efficiency ⁽¹⁾ typ. [%]	Max. Capacitive Load [µF]
RPA20-243.3SAW ^(2,3)	9-36	3.3	6000	948	87	10000
RPA20-2405SAW ^(2,3)	9-36	5	4000	947	88	10000
RPA20-2412SAW ^(2,3)	9-36	12	1670	949	88	1000
RPA20-2415SAW ^(2,3)	9-36	15	1330	945	88	1000
RPA20-2412DAW ^(2,3)	9-36	±12	±830	949	88	±1000
RPA20-2415DAW ^(2,3)	9-36	±15	±670	945	88	±680

Notes:

Note1: tested at nominal Vin, full load and at +25°C ambient

Model Numbering

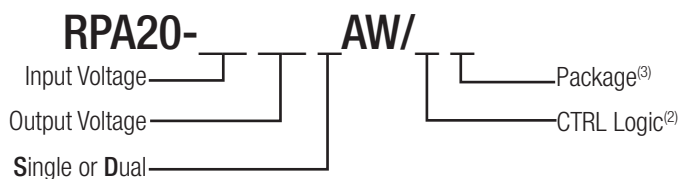

Ordering Examples

- RPA20-243.3SAW = 24V Input, 3.3V Output, Single, no CTRL pin
- RPA20-2405DAW/P = 24V Input, 5V Output, Dual, Pos. CTRL function
- RPA20-2415SAW-HC = 24V Input, 15V Output, Single, no CTRL pin, glued Heat-sink
- RPA20-2415DAW/N-HC = 24V Input, 15V Output, Dual, Neg. CTRL function, glued Heat-sink

Notes:

- Note2: part without suffixes is without CTRL pin, trim pin fitted
add suffix "P" for positive CTRL function (1=ON, 0=OFF), trim pin fitted
add suffix "N" for negative CTRL function (0=ON, 1=OFF), trim pin fitted
trim pin is only available for single outputs
- Note3: add suffix "-HC" for glued Heat-sink (compatible with all other suffixes)

Specifications measured @ $t_a = 25^\circ\text{C}$, resistive load, nominal V_{in} and rated I_{out} unless otherwise noted

BASIC CHARACTERISTICS				
Parameter	Condition	Min.	Typ.	Max.
Internal Input Filter				Pi-Type
Input Voltage Range		9VDC	24VDC	36VDC
Input Surge Voltage	100ms max.			50VDC
Quiescent Current		20mA		55mA
Start-up time	Power up CTRL ON/OFF		8ms	16ms
Internal Operating Frequency			550kHz	
Minimum Load		0%		
Ripple and Noise	20MHz BW, 10 μF tantalum capacitor and 1 μF ceramic capacitor		50mVp-p	
Under Voltage Lockout (UVLO)	DC-DC ON	8VDC	8.5VDC	9VDC
	DC-DC OFF	7VDC	7.5VDC	8VDC
ON/OFF Control	Positive Logic DC-DC ON DC-DC OFF			Open or $2.4 < V_r < 10\text{VDC}$ Short or $0 < V_r < 0.8\text{VDC}$
	Negative Logic DC-DC ON DC-DC OFF			Short or $0 < V_r < 0.8\text{VDC}$ Open or $2.4 < V_r < 10\text{VDC}$
Input current of CTRL pin			6mA	
Output Voltage Trimming	Single Outputs	-10%		+10%

RPA20-243.3SAW

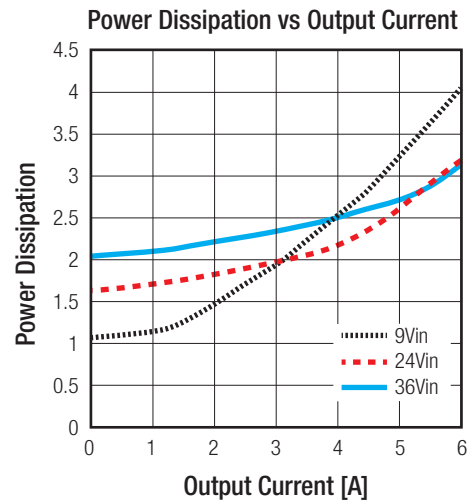
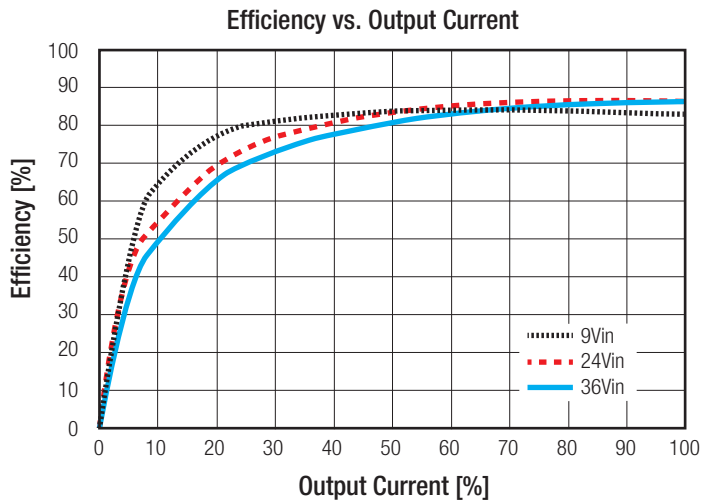

RPA20-2405SAW

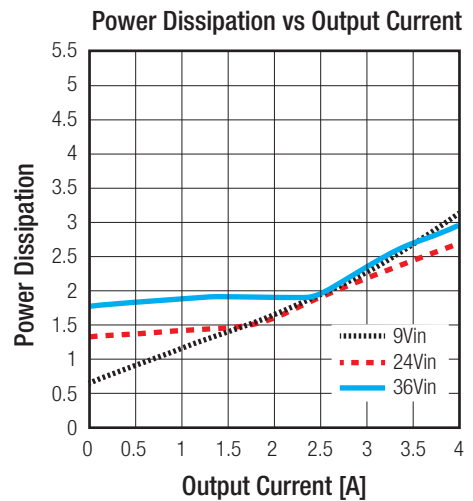
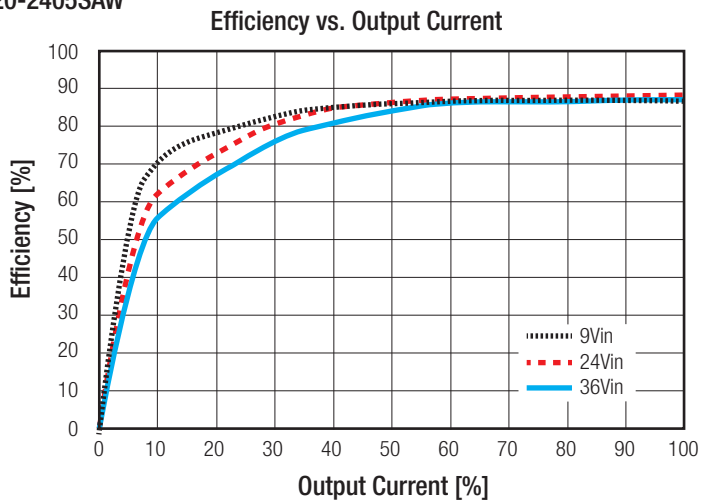

continued on next page

Specifications measured @ $t_a = 25^\circ\text{C}$, resistive load, nominal V_{in} and rated I_{out} unless otherwise noted

RPA20-2412SAW

Efficiency vs. Output Current

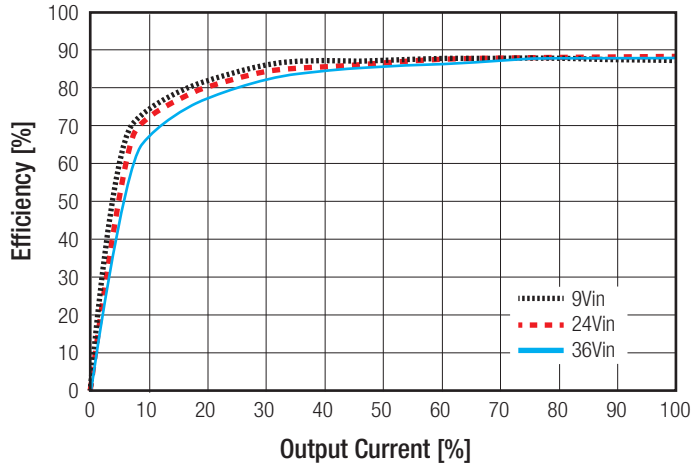

Power Dissipation vs Output Current

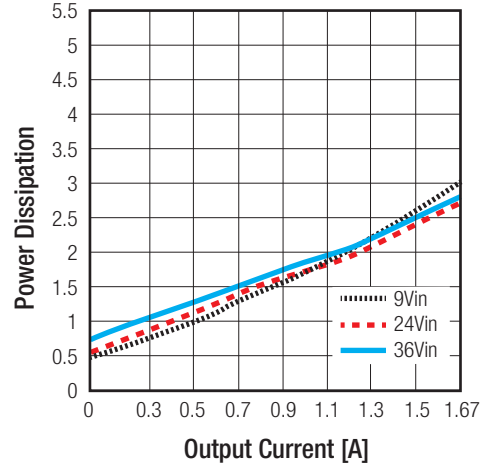

RPA20-2415SAW

Efficiency vs. Output Current

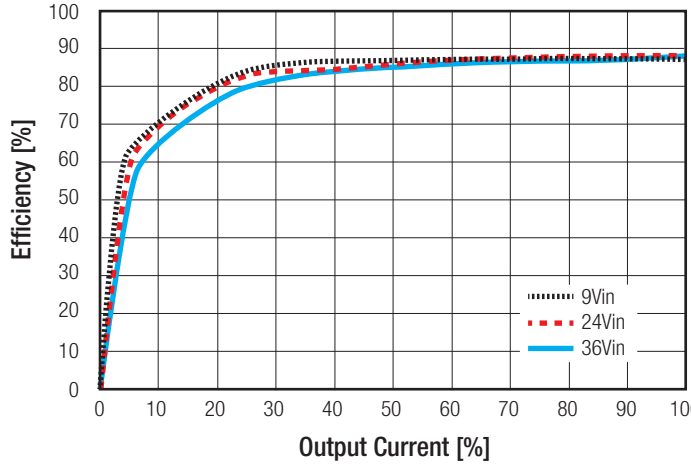

Power Dissipation vs Output Current

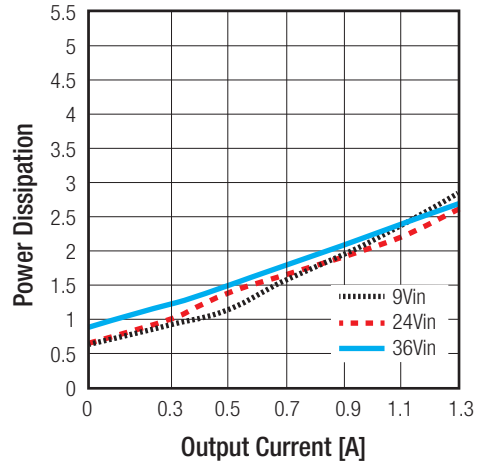

RPA20-2412DAW

Efficiency vs. Output Current

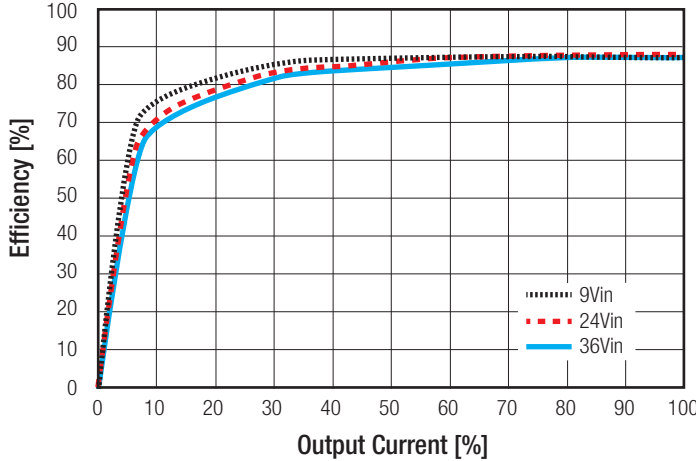

Power Dissipation vs Output Current

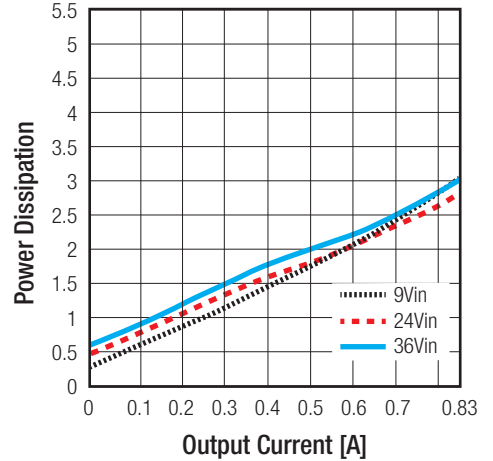

continued on next page

Specifications measured @ $t_a = 25^\circ\text{C}$, resistive load, nominal V_{in} and rated I_{out} unless otherwise noted

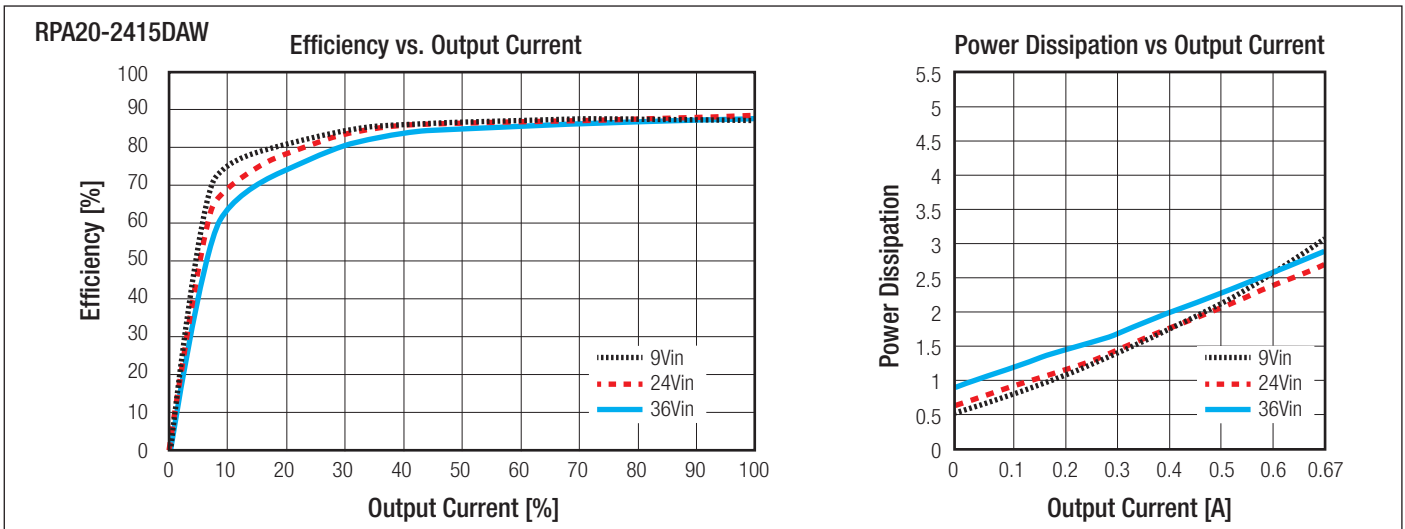

OUTPUT TRIM

Output Voltage Trimming

RPA20-AW converters offer the feature of trimming the output voltage over a certain range around the nominal value by using external trim resistors. The values for trim resistors shown in trim tables below are according to standard E96 values; therefore, the specified voltage may slightly vary.

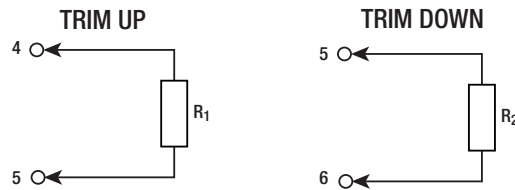

RPA20-243.3SAW

Trim up	1	2	3	4	5	6	7	8	9	10	%
$V_{out} =$	3.33	3.36	3.39	3.43	3.46	3.49	3.53	3.56	3.59	3.63	Volts
$R_U =$	402	169	100	75	47.5	34.8	26.1	17.8	12.1	8.06	kOhms
Trim down	1	2	3	4	5	6	7	8	9	10	%
$V_{out} =$	3.27	3.23	3.20	3.17	3.14	3.10	3.07	3.04	3.0	2.97	Volts
$R_D =$	402	191	113	75	52.3	39.2	26.7	20	12.1	8.06	kOhms

RPA20-2405SAW

Trim up	1	2	3	4	5	6	7	8	9	10	%
$V_{out} =$	5.05	5.10	5.15	5.20	5.25	5.30	5.35	5.40	5.45	5.50	Volts
$R_U =$	604	243	147	95.3	68.1	39.2	34.8	22.1	15	8.06	kOhms
Trim down	1	2	3	4	5	6	7	8	9	10	%
$V_{out} =$	4.95	4.90	4.85	4.80	4.75	4.70	4.65	4.60	4.55	4.50	Volts
$R_D =$	604	287	169	124	105	78.7	54.9	39.2	15	0.5	kOhms

RPA20-2412SAW

Trim up	1	2	3	4	5	6	7	8	9	10	%
$V_{out} =$	12.12	12.24	12.36	12.48	12.6	12.72	12.84	12.96	13.08	13.20	Volts
$R_U =$	604	267	162	105	75	499	40.2	24.9	18.2	10	kOhms
Trim down	1	2	3	4	5	6	7	8	9	10	%
$V_{out} =$	11.88	11.76	11.64	11.52	11.40	11.28	11.16	11.04	10.92	10.80	Volts
$R_D =$	750	309	200	124	90.9	64.9	45.3	32.4	20	12.1	kOhms

continued on next page

Specifications measured @ $t_a = 25^\circ\text{C}$, resistive load, nominal V_{in} and rated I_{out} unless otherwise noted

RPA20-2415SAW											
Trim up	1	2	3	4	5	6	7	8	9	10	%
$V_{out} =$	15.15	15.30	15.45	15.60	15.75	15.90	16.05	16.20	16.35	16.50	Volts
$R_U =$	1000	243	200	130	90.9	61.9	40.2	30.1	24.9	10	kOhms
Trim down	1	2	3	4	5	6	7	8	9	10	%
$V_{out} =$	14.85	14.70	14.55	14.40	14.25	14.10	13.95	13.80	13.65	13.50	Volts
$R_D =$	1000	348	210	140	95.3	68.1	45.3	30.1	18.2	8.06	kOhms

REGULATION			
Parameter	Condition	Value	
Output Accuracy	Single & Dual	$\pm 0.1\%$ typ., $\pm 2.0\%$ max.	
Line Regulation	low line to high line	Single	$\pm 0.1\%$ typ., $\pm 0.2\%$ max.
		Dual	$\pm 0.1\%$ typ., $\pm 0.5\%$ max.
Load Regulation	3.3V _{out}	$\pm 0.3\%$	
	5V _{out}	$\pm 0.2\%$	
	12V _{out} , 15V _{out}	$\pm 0.1\%$	
	$\pm 12V_{out}$, $\pm 15V_{out}$	$\pm 1.0\%$	
Cross Regulation	asymmetrical 25% \leftrightarrow 100% load	$\pm 2.0\%$ typ., $\pm 3.0\%$ max.	
Transient Response	50-75%, full load, 0.1A/ μ s	$\pm 3.0\%$ typ.	
	25% load step change	250 μ s typ.	

PROTECTION		
Parameter	Condition	Value
Short Circuit Protection (SCP)	below 100m Ω	continuous, auto recovery
Over Voltage Protection (OVP)		115%-150% Output Voltage, Hiccup, auto recovery
Over Current Protection (OCP)		110%-160% Output Current, Hiccup
Over Temperature Protection (OTP)		115°C $\pm 5^\circ\text{C}$
Isolation Voltage ⁽⁶⁾	I/P to O/P	tested for 1 minute
Isolation Resistance		10M Ω min.
Isolation Capacitance		1100pF typ.
Insulation Grade		basic

Notes:

Note4: An input fuse is required if the mains supply is not over-current protected. Recommended fuse: 3A slow blow type

Note5: For repeat Hi-Pot testing, reduce the time and/or the test voltage

ENVIRONMENTAL		
Parameter	Condition	Value
Operating Temperature Range ⁽⁶⁾		-40°C to [refer to thermal calculation]
Maximum Case Temperature		+105°C
Temperature Coefficient		0.02%/°C
Thermal Impedance		please refer to table 1
Operating Altitude		2000m
Operating Humidity		95% RH
Shock		30G, 11ms, 3 times along X,Y and Z axis
Vibration		10-500Hz, 2.4G, 30mins along X,Y and Z axis
MTBF	according to Telcordia SR332 3, +25°C	5800 x 10 ³ hours

continued on next page

Specifications measured @ $t_a = 25^\circ\text{C}$, resistive load, nominal V_{in} and rated I_{out} unless otherwise noted

Table 1: Thermal Impedance

airflow [m/s]	without Heatsink		with Heatsink	
	R _{th} without PCB [°C/W]	R _{th} with PCB ⁽⁶⁾ [°C/W]	R _{th} without PCB [°C/W]	R _{th} with PCB ⁽⁶⁾ [°C/W]
0.1	17.8	12.5	16.0	11.3
0.2	16.0	11.2	14.4	10.1
0.5	14.0	9.7	12.6	8.7
1.0	10.0	7.1	9.0	6.4
1.5	8.3	5.8	7.5	5.2
2.0	6.3	4.4	5.7	4.0

Notes:

Note6: Test PCB:160x100mm105μm (Eurocard), double layer

Thermal Calculation

choose your model:

RPA20-2405SAW (with PCB ⁽⁶⁾)

- Load conditions in application (e.g. 100%)
- Airflow conditions in application (e.g. 0.5m/s)
- use R_{th} from Table1 (9.7°C/W)

Calculation:

$$\begin{aligned}
 I_{out} &= 100\% \\
 R_{th} &= 9.7^\circ\text{C/W} \\
 P_{DISS} &= 2.8\text{W} \\
 T_{CASEmax} &= 105^\circ\text{C}
 \end{aligned}$$

$$T_{OVER} = R_{th} \times P_{Dis} = 9.7^\circ\text{C/W} \times 2.8\text{W} = 27.2^\circ\text{C}$$

$$T_{AMBmax} = T_{CASEmax} - T_{OVER} = 105^\circ\text{C} - 27.2^\circ\text{C} = 77.8^\circ\text{C}$$

choose your model:

RPA20-2405SAW-HC (with PCB ⁽⁶⁾)

- Load conditions in application (e.g. 100%)
- Airflow conditions in application (e.g. 0.5m/s)
- use R_{th} from Table1 (8.7°C/W)

Calculation:

$$\begin{aligned}
 I_{out} &= 100\% \\
 R_{th} &= 8.7^\circ\text{C/W} \\
 P_{DISS} &= 2.8\text{W} \\
 T_{CASEmax} &= 105^\circ\text{C}
 \end{aligned}$$

$$T_{OVER} = R_{th} \times P_{Dis} = 8.7^\circ\text{C/W} \times 2.8\text{W} = 24.4^\circ\text{C}$$

$$T_{AMBmax} = T_{CASEmax} - T_{OVER} = 105^\circ\text{C} - 21.3^\circ\text{C} = 80.6^\circ\text{C}$$

RPA20-24xxSAW

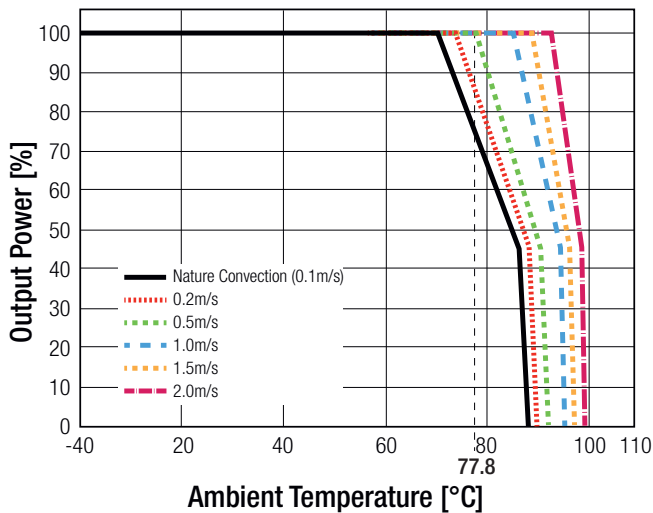

RPA20-24xxSAW-HC

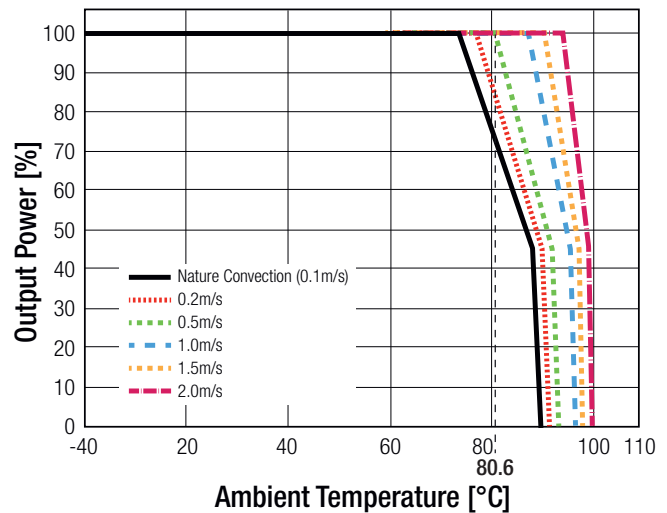

SAFETY AND CERTIFICATIONS

Certificate Type (Safety)	Report / File Number	Standard
Information Technology Equipment, General Requirements for Safety	E224736-A39 + A40	UL60950-1, 2nd Edition, 2014 CSA C22.2 No. 60950, 2nd Edition, 2014
IEC/EN Information Technology Equipment - General Requirements for Safety (CB Scheme)	E224736-A39-CB + A40-CB	IEC60950-1, 2nd Edition, 2005 + AM2, 2013 EN60950-1, 1st Edition, 2006 + AM2, 2013
Railway Applications - Electrical Equipment used on rolling stock	15100175 001, 15100176 001	EN50155, 1st Edition, 2007, Clause 5.4 and 5.5
RoHS 2+		RoHS 10/10, 2011/65/EU + AM-2015/863

continued on next page

Specifications measured @ $t_a = 25^\circ\text{C}$, resistive load, nominal V_{in} and rated lout unless otherwise noted

EMC Compliance (designed to meet)	Condition	Standard / Criterion
Information technology equipment - Radio disturbance characteristics Limits and methods of measurement	with external filter	EN55022, Class A, 2010
Railway applications - Electromagnetic compatibility Part 3-2: Rolling stock - Apparatus		EN50121-3-2, 2015
Specification for radio disturbance and immunity measuring apparatus and methods Part 2-1: Methods of measurement of disturbances and immunity – Conducted disturbance measurements		EN55016-2-1, 2009
Specification for radio disturbance and immunity measuring apparatus and methods Part 2-3: Methods of measurement of disturbances and immunity – Radiated disturbance measurements		EN55016-2-3, 2010
ESD Electrostatic discharge immunity test	Air $\pm 8\text{kV}$, Contact $\pm 6\text{kV}$	EN61000-4-2, 2009; Criteria A
Radiated, radio-frequency, electromagnetic field immunity test	20V/m, 80-1000MHz 10V/m, 1.4-2.0GHz 5V/m, 2.0-2.7GHz 3V/m, 5.1-6.0GHz	EN61000-4-3, 2006; Criteria A
Fast Transient and Burst Immunity	$\pm 2\text{kV}$	IEC61000-4-4, 2004; Criteria A
Surge Immunity	$\pm 1\text{kV}$	EN61000-4-5, 2006; Criteria A
Immunity to conducted disturbances, induced by radio-frequency fields	10V	EN61000-4-6, 2009; Criteria A

EMI Filtering according to EN50121-3-2 and EN55022 Class A

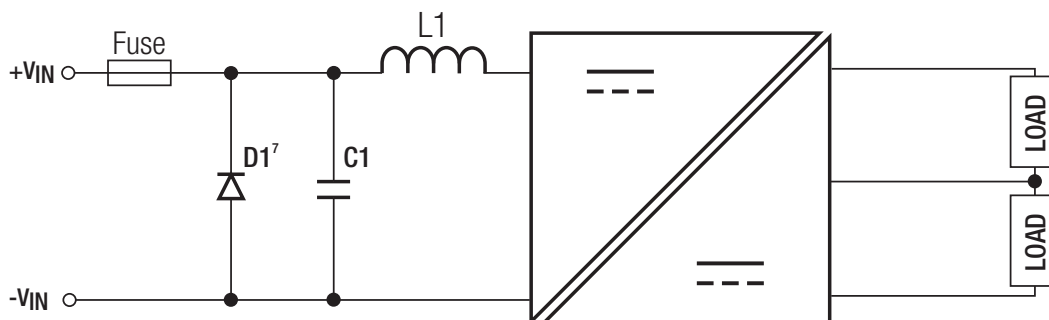

Notes:

Note7: Diode is only needed for EN50155

C1	L1
47 μF /50V electrolyt capacitor	1 μH Choke

DIMENSIONS and PHYSICAL CHARACTERISTICS

Parameter	Type	Value
Material	case	Al Alloy, anodize black
	baseplate	non-conductive FR4
	potting	Silicone (UL94-V0)
Package Dimensions (LxWxH)	without Heat-sink	25.4 x 25.4 x 10.2mm
	with Heat-sink	25.4 x 25.4 x 16.8mm
Package Weight	without -Heat-sink	17g typ.
	with Heat-sink	21g typ.

continued next page

Specifications measured @ $t_a = 25^\circ\text{C}$, resistive load, nominal V_{in} and rated I_{out} unless otherwise noted

Dimension Drawing (mm)

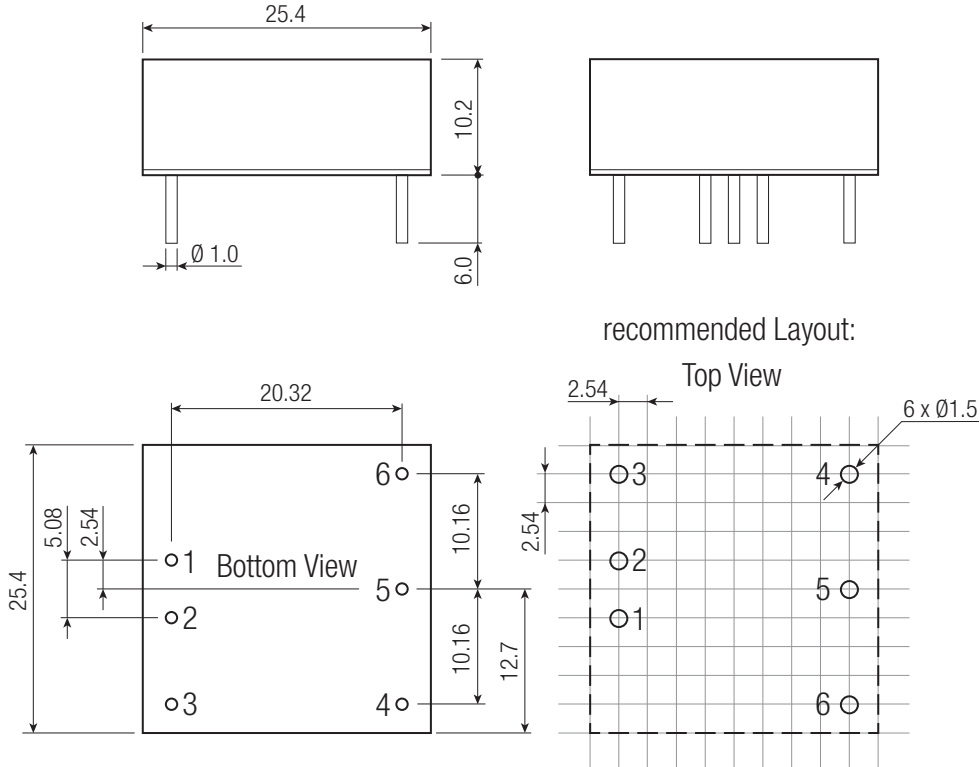
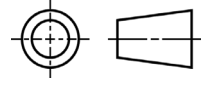

Heat-sink Dimension Drawing (mm)

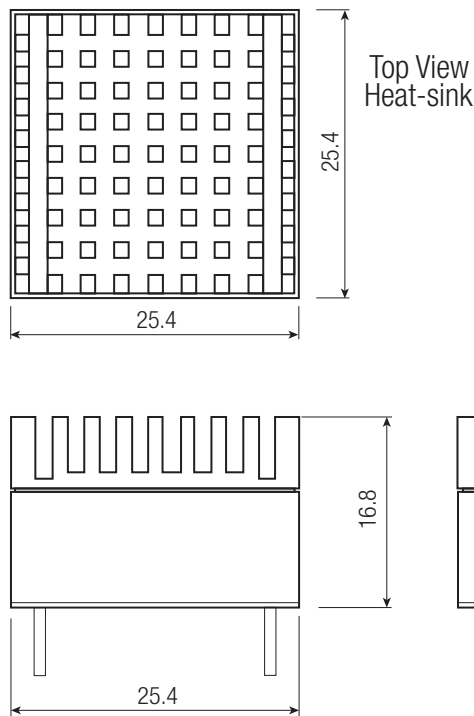

Pin Connections

Pin #	Single	Dual
1	+Vin	+Vin
2	-Vin	-Vin
3	CTRL ⁽²⁾	CTRL ⁽²⁾
4	-Vout	-Vout
5	Trim	Com
6	+Vout	+Vout

Pin Pitch Tolerance $\pm 0.25\text{mm}$
Pin dimension tolerance $\pm 0.1\text{mm}$
XX.X $\pm 0.5\text{mm}$
XX.XX $\pm 0.25\text{mm}$

Specifications measured @ $t_a = 25^\circ\text{C}$, resistive load, nominal V_{in} and rated lout unless otherwise noted

PACKAGING INFORMATION			
Parameter	Type		Value
Packaging Dimensions (LxWxH)	without Heat-sink	tube	285.0 x 27.6 x 19.0mm
	with Heat-sink		285.0 x 27.6 x 25.8mm
Packaging Quantity			10pcs
Storage Temperature Range			-55°C to +125°C
Storage Humidity			5% - 95% RH

The product information and specifications may be subject to changes even without prior written notice. The product has been designed for various applications; its suitability lies in the responsibility of each customer. The products are not authorized for use in safety-critical applications without RECOM's explicit written consent. A safety-critical application is an application where a failure may reasonably be expected to endanger or cause loss of life, inflict bodily harm or damage property. The applicant shall indemnify and hold harmless RECOM, its affiliated companies and its representatives against any damage claims in connection with the unauthorized use of RECOM products in such safety-critical applications.